

Signal Consulting, LLC

16 Wilelinor Drive, Edgewater, MD 21037-1003 USA

Phone: 410-224-8429, Fax: 410-510-1821, E-mail: info@signallc.com

Si15NeUdPC1-50V-20A, Networkable, Unidirectional, 50V 20A, Power Controller with RS232 Serial Control Port, Display Port, Integrated Heat Sink and with 6.2kHz or 25kHz PWM, B-Chip

The **Si15NeUdPC1-50V-20A** is a 50V 20A, networkable, microprocessor based, high-power, Unidirectional, Power Controller that uses a single (15V to 50V at 0 to 20A) DC power supply to control the average current to load (or DC motor) in one direction. An onboard microprocessor generates a 6.2kHz or 25kHz **PWM** carrier signal, controls the load-power (or motor speed), controls the load-current rate (or motor acceleration and deceleration), updates the display, monitors the user inputs and controls the RS232 Network Port. As the name (**Ne, Networkable**) implies, the %PWM (PWM pulse-duration) of the motor current is variable from 0 to +100% in 0.83% steps by using ASCII command strings on the RS232 Network Port; or it can be changed by using external **UP/DOWN keys** connected to **J2 and J3**. The RS232 data format and the Local Area Network (LAN) commands are described on the next page. The **PWM** carrier frequency is selectable by the Dip-Switch **S3**, 6.2kHz when **S3** is short and 25kHz when open. In addition, the user can choose between slow or fast motor acceleration/deceleration values using Dip-Switch **S4**. The fast-ramp, with rise-time/fall-time of 0.05s, is selected with **S4** open; while slow-ramp, with rise-time/fall-time of 0.5s, is selected **S4** closed. All control lines are sampled approximately at 20Hz rate in the fast mode (**S4** open), and at 8Hz rate in the slow mode (**S4** closed). An external Normally Open Switch or an Open Collector NPN transistor can be connected to **J1** port to disable the load current (**J1** Open=Run, **J1** Short=Stop). The active pin of **J1** is internally connected to +5V using a 4.7k Ohm resistor (as shown on the diagram below). The Jumper and Dip-Switch selection tables are shown below. A red LED is used to monitor the motor (or load) voltage. A 9600 Baud serial port (**CN4**) with 5V RS232 Interface standard is provided to display of the Motor Speed data on an optional [Si14LCD2L16CH-3PC](#) LCD using a 2-Line by 16-Character format (described below). A small (2.4"x2.3"x0.5"), integrated Aluminum heat-sink is used to operate at 20A current levels. Higher current-levels (25A or 1200W) can be achieved with more efficient heat-sinks. Please click on this link and read the [Board Mounting Instructions and Heat Sink Selection Guide](#). This board operates in a wide voltage-range (9V to 30V) at max. continuous load-current of 20A. Typical applications are: Unidirectional DC Motor-Speed Controller, Flicker-free LED light intensity control, Proportional Valve-Coil Controller, etc. This board can be configured and programmed to perform efficiently in many customized applications.

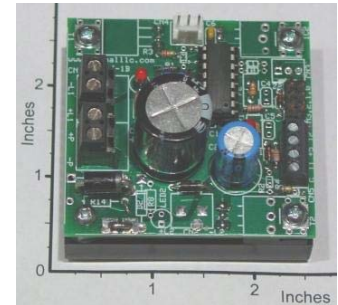

Dip-Switch Selection Table

S4 Open = Fast Ramp Time, 0.05 sec	S4 Short = Slow Ramp Time, 0.5 sec
S3 Open = 25kHz PWM Frequency	S3 Short = 6.2kHz PWM Frequency

Jumper Selection Table

J1 Open = Motor Runs With PWM	J1 Short = Motor Stops
J2 Open = Normal Networkable Operation	J2 Short = Increment Set RPM
J3 Open = Normal Networkable Operation	J3 Short = Decrement Set RPM

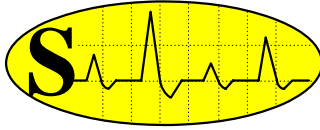

Signal Consulting, LLC

16 Wilelinor Drive, Edgewater, MD 21037-1003 USA

Phone: 410-224-8429, Fax: 410-510-1821, E-mail: info@signallc.com

Note: The Jumpers **J1, J2, J3** are examined at each sampling period (loop-time). While the Dip-Switches **S4** and **S3** are examined only at power turn-on.

Specification and Application of Si15NeUdPC1-50V-20A

- Lead free / RoHS Compliant, 
- **Typical Operating Temperature at 20A:** 45°C with the Metal Heat-Ring Bolted to a small (2.4"x2.3"x0.5") Finned Aluminum heat-sink, while the heat-sink is exposed to ambient air at 25°C (as shown on photograph).
- **Overall Dimensions:** Length=2.4", Width=2.3", Height=1.55" Inches, (L=61, W=59, H=40 mm).
- **Source-Voltage Requirements:** V_p (from pin +P to pin -P): 15V to 50V DC.
- **Average Load Voltage (from pin +L to pin -L):** 0V at 0% Duty-Cycle and V_p at 100% Duty-Cycle.
- **Max. Continuous Load Current:** 20A at 100% Duty-Cycle.
- **Max. Load Current for 5Sec:** 40A at 100% Duty-Cycle.
- **Kill Switch Port, J1:** An external Normally Open Switch or an Open Collector NPN transistor can be connected to J1 port to disable the load current (J1 Open=Run, J1 Short=Stop). The active pin of J1 is internally connected to +5V using a 4.7k Ohm resistor (as shown on the diagram below).
- **PWM Frequency Select, S3:** Frequency is 6.2kHz when S3 is short and 25kHz when S3 is open.
- **Two User Selectable Motor Acceleration/Deceleration Modes :** Using Dip-Switch S4
- **Load Isolation:** The Load or Motor must be isolated from the source voltage (V_p).
- **Power-Conversion Efficiency:** Approximately 98.5% at full-load (30V and 20A).
- **Load-Current Indicator:** An onboard red LED is used to monitor the motor (or load) voltage.
- **About the Voltage Requirement:** The Si15 will work with any DC Load in the 15V to 50V range. In addition, the power filters are included on this board. Consequently, only unregulated (full-wave rectified) DC input power is required in most applications.

A Typical Application of the Si15NeUdPC1-50V-20A

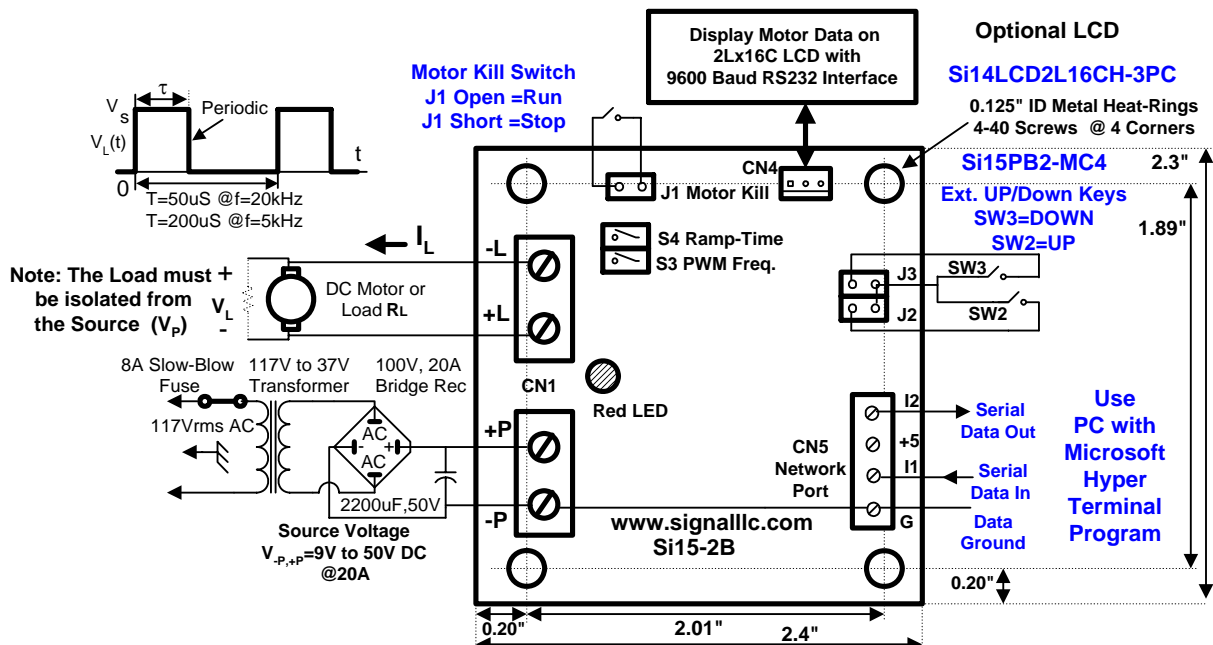

In this open-loop application, the PWM or motor speed is adjusted by command strings derived from a Personal Computer (PC) using the Microsoft "Hyper Terminal" program (or any-other ASCII controller)

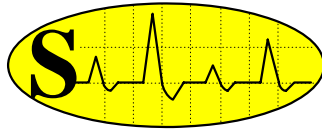

Signal Consulting, LLC

16 Wilelinor Drive, Edgewater, MD 21037-1003 USA

Phone: 410-224-8429, Fax: 410-510-1821, E-mail: info@signallc.com

operating at 9600 Baud, 1 start-bit, 8 data-bits, 1 stop-bit, No parity-bit. In addition, the PWM can be adjusted with Up/Down Keys ([Si15PB2-MC4](#)) connected to pins **J2** and **J3**. An optional serial LCD module [Si14LCD2L16CH-3PC](#) (2-Line by 16-character LCD with back light and 12" cable) can be connected port **CN4** to display the set and measured %PWM values. **Warning: The connecting wires to the Load and the Power Supply must be heavy gauge copper wire (#12 AWG or heavier) to handle the rated current level. In addition, these heavy gauge wires act as a heat sink, protecting the board from overheating.**

Command Format and Local Area Network (LAN) for the [Si15NeUdPC1-50V-20A](#)

Each board has a unique, 8-bit, ASCII, **none-volatile**, Node-Address ranging from 1....9, A..Z, a,...z (or a total of 61 Units can be networked). The address can be changed by a **LAN** command (the factory default address is 1). The board uses a modified version of the RS232 serial-data communication standard, where the output-voltage (on pin **I2**, **CN5**) ranges from 0 to +5V (rather than the usual -12V to +12V). In addition, this output pin is normally an open circuit and it will only output a serial TTL binary bit-stream when properly referenced by its Node-Address. The serial data input-voltage (on pin **I1**, **CN5**) has the standard range of -12V to +12V. The serial data-format is: 9600 Baud Rate, 1 Start-Bit, 8 Data-Bits, 1 Stop-Bit, and no Parity-Bit.

These features allow the creation of a Local Area Network (**LAN**) with up to 61 nodes (boards). A typical 3-wire **LAN** with "Star Topology" is shown below. Note that the control lines (**G**, **I1**, **I2**) with the same name are connected together (or the boards are connected in parallel) and driven by an **ASCII** controller (or **PC**), equipped with an RS232 serial port, operating at 9600 Baud rate.

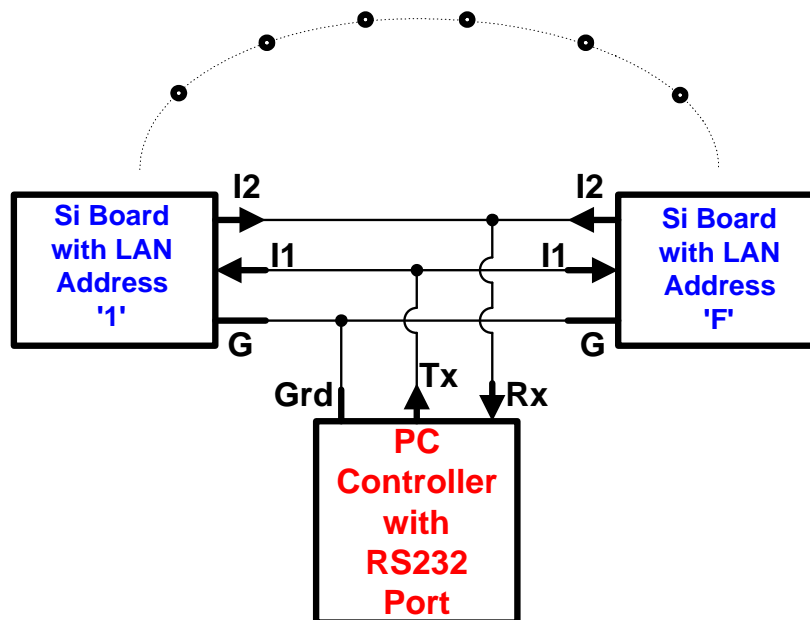

Command Rules:

1. All Commands are **ASCII** character strings (Chars.). An ASCII string is denoted here with **Bold Red Letters (Characters)**.

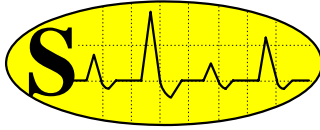

Signal Consulting, LLC

16 Wilelinor Drive, Edgewater, MD 21037-1003 USA

Phone: 410-224-8429, Fax: 410-510-1821, E-mail: info@signallc.com

2. Each string is terminated by a Carriage Return Character, **(CR)**. The only exception is the **#** command.
3. Upper-Case Letters are used for Output Commands; and Lower-Case Letters are used for Input Commands.
4. The 1st Char. in a string is either ASCII **#** or a Node Address (**1, ..,9,A..Z, a,..,z**). If the 1st Char. is an **#**, it denotes a query to all boards on the LAN to output their Node Address and Program Name.
5. If the 1st Char. is an ASCII (**1,..,9,A,..Z, a,..,z**), it directs the rest of the command string to the board that has this address.
6. The 2nd Char. in the string is the Command Character that operates on the addressed board.
7. The 3rd, 4th, 5th Chars. represents the value of the input data.
8. The last Char. in the sequence is always the string terminator, **(CR)**.

Command Examples:

Ex#1. Com. String: **#** Action: All boards on the LAN will output their Address and Program Name.

Ex#2. Com. String: **1u5(CR)** Action: Change Board 1 Address in EPROM from 1 to 5.

Ex#3. Com. String: **1M(CR)** Action: Board 1 outputs its Set and Measured Values (0,..120).

Ex#4. Com. String: **1m120(CR)** Action: Change Board 1 Load Value to 120 = 100% PWM.

Ex#5. Com. String: **2m60(CR)** Action: Change Board 2 Motor Value to 60 = 50% PWM.

We recommend that you use approximately 25msec (or longer) delays between characters when inputting a command string ("1m..(CR)", "1M(CR)") to this controller board.

Occasionally, a transient character may be captured and buffered by one more board on the LAN, this **transient character can be cleared by sending one or more (CR) prior to a valid command string.**

Note1: The **m** command inputs decimal integer Motor Values, ranging from 0,...+120. The positive values are used for forward speed control. The PWM duty-cycle varies linearly with the input values; 0 value is equal to 0% PWM, while 120 value is equal to 100% PWM.

Note2: The **m** command is **NOT** subject to round-off" errors!!!

Note3: The last set value entered with the **m** command or with the Up/Down keys is saved when the power is turned off, and this value is restored when the power is turned back on.

Response to Commands on Output Line I2:

The response to a "**1M(CR)**" command is an ASCII character string (or a line of characters). Each string is terminated with carriage return and line feed characters. An example is shown below:

N=1 SM=120 MM=120

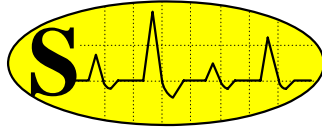

Signal Consulting, LLC

16 Wilelinor Drive, Edgewater, MD 21037-1003 USA

Phone: 410-224-8429, Fax: 410-510-1821, E-mail: info@signallc.com

Note that there are two space characters between **1** and **S**; and there are two space characters between **C** and **M**. The length of this character string is 22, including carriage return and line feed characters (not shown in this example).

Where **N=1** is the node (or unit) address of the board (can be changed with the **u** command), **SM=120** is the last Set-Motor Speed Value (entered with the **m** command), and **MM=120** is the current Measured-Motor Speed Value.

Each character string (line) is a continuous stream of ASCII characters with an occasional pause (or delay) between characters. This delay is approximately 1msec.

CN4 Display Format:

A 9600 Baud serial port (**CN4**) with 5V RS232 Interface standard is provided for optional display of the %PWM Motor-Current data.

Si14LCD2L16CH-3PC 2-Line by 16-Character LCD on Port CN4 with Display Format:

Line#1: **SM=120 MM=120** or Measured Motor-Current PWM is 100%.

Line#2: **N=1 B=xxxxxxxx** or **N**=Node Address, **B**= Commands Entered.

For more information on Displays, please click on these links: ([Si14LCD2L16CH-3PC](#) , [Si4Display-Spec1](#)).

Network Configuration:

The on-board microprocessor provides the bus arbitration, required to avoid data collisions on the 3-wire LAN bus. The **Si..Ne..** boards can be arranged in many Local Area Network (LAN) topologies: Star, Daisy-Chain, etc. You may create your own network or you may order one or more of the Network Cable Assemblies listed in the Application Note. **Before you build your network, click on this blue link and read this Application Note:** [SigNote on Configuring a LAN-2](#).